



Vehicle History Report™

US \$44.99

2017 NISSAN ROGUE S

VIN: KNMAT2MT3HP564286
4 DOOR WAGON/SPORT UTILITY
2.5L I4 F DOHC 16V GASOLINE
FRONT WHEEL DRIVE
Original Window Sticker

Branded Title: Salvage

8 Service history records

At least 1 open recall

4 Previous owners

Types of owners: Rental, Personal

115,667 Last reported odometer reading

CARFAX HAS THE MOST ACCIDENT & DAMAGE INFORMATION



This CARFAX Vehicle History Report is based only on information supplied to CARFAX and available as of 1/24/26 at 2:51:04 AM (CST). Other information about this vehicle, including problems, may not have been reported to CARFAX. Use this report as one important tool, along with a vehicle inspection and test drive, to make a better decision about your next used car.



Accident / Damage History

Not all accidents / issues are reported to CARFAX

Event 1

09/29/2022

Accident reported

- Vehicle was not damaged

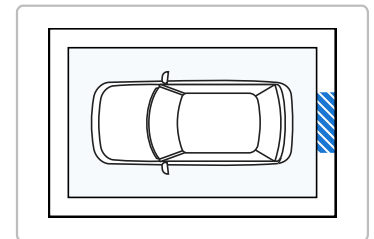

Event 2

11/19/2025

Damage reported: moderate damage

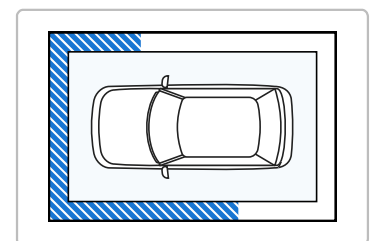
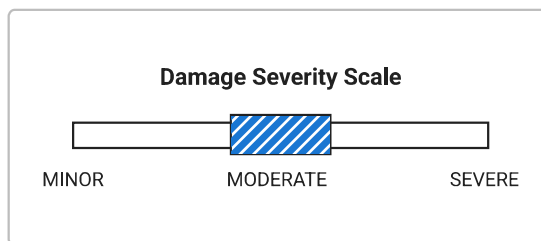

Event 3

12/30/2025

TOTAL LOSS VEHICLE

 Additional History Not all accidents / issues are reported to CARFAX	Owners 1-2	Owner 3	Owner 4
Total Loss Total Loss Reported: 12/30/2025.	<input checked="" type="checkbox"/> No Issues Reported	<input checked="" type="checkbox"/> No Issues Reported	Total Loss Reported
Structural Damage CARFAX recommends that you have this vehicle inspected by a collision repair specialist.	<input checked="" type="checkbox"/> No Issues Reported	<input checked="" type="checkbox"/> No Issues Reported	<input checked="" type="checkbox"/> No Issues Reported
Airbag Deployment No airbag deployment reported to CARFAX.	<input checked="" type="checkbox"/> No Issues Reported	<input checked="" type="checkbox"/> No Issues Reported	<input checked="" type="checkbox"/> No Issues Reported
Odometer Check No indication of an odometer rollback.	<input checked="" type="checkbox"/> No Issues Indicated	<input checked="" type="checkbox"/> No Issues Indicated	<input checked="" type="checkbox"/> No Issues Indicated
Accident / Damage DMV title problems reported. Accident reported: 09/29/2022. Damage reported: 11/19/2025.	Accident Reported	No New Issues Reported	Severe Damage
Manufacturer Recall At least 1 manufacturer recall requires service. Locate an authorized Nissan dealer near you to schedule an appointment.	Recall Reported	No New Recalls Reported	No New Recalls Reported
Basic Warranty Original manufacturer warranty likely voided by manufacturer.	<input checked="" type="checkbox"/> Warranty Active	<input checked="" type="checkbox"/> Warranty Active	Warranty Voided

 Title History	Owners 1-2	Owner 3	Owner 4
Damage Brands Salvage Junk Rebuilt Fire Flood Hail Lemon	No Problem	No Problem	Alert! Problem Found
Odometer Brands Not Actual Mileage Exceeds Mechanical Limits	No Problem	No Problem	No Problem



ALERT! - Severe problems were reported by a state Department of Motor Vehicles (DMV). This vehicle does not qualify for the CARFAX Buyback Guarantee.

 Ownership History The number of owners is estimated	Owners 1-2	Owner 3	Owner 4
---	------------	---------	---------



Year purchased	2017	2023	2025
Type of owner	See Details	Personal	Personal
Estimated length of ownership	6 yrs. 6 mo.	2 years	2 months
Owned in the following states/provinces	See Details	Rhode Island	Rhode Island
Estimated miles driven per year	See Details	--	--
Last reported odometer reading	82,493	96,252	115,667



CARFAX Detailed History

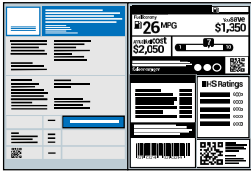

Owner 1
Purchased: 2017

Rental Vehicle
31,441 mi/yr

Date	Mileage	Source	Comments
Not Reported		Nissan North America, Inc.	Original Window Sticker 
03/23/2017	5	Virginia Motor Vehicle Dept. Virginia Beach, VA	Vehicle purchase reported - Title or registration issued - First owner reported - Loan or lien reported - Titled or registered as rental vehicle
04/04/2017		Virginia Inspection Station	Passed safety inspection
05/31/2017	6,772	Sears Auto Center De Witt, NY 315-445-3828 searsauto.com ★ 4.8 / 5.0 32 Verified Reviews	 Vehicle serviced - Maintenance inspection completed - Alignment checked - Oil and filter changed - Tires rotated
06/06/2018	37,902	Boch Toyota South North Attleboro, MA 508-699-7551 bochtoyotasouth.com ★ 4.6 / 5.0 593 Verified Reviews ❤️ 29 Customer Favorites	Vehicle offered for sale



06/18/2018	Boch Toyota South North Attleboro, MA 508-699-7551 bochtoyotasouth.com		Vehicle serviced - Maintenance inspection completed - Air filter replaced - Brakes checked - Cabin air filter checked - Cabin air filter replaced/cleaned - Electrical system checked - Four tires balanced - Front brake rotor(s) resurfaced - Front wiper blades/refills replaced - Tire condition and pressure checked
★ 4.6 / 5.0 593 Verified Reviews ❤️ 29 Customer Favorites			
Looks like this dealer serviced the car in order to prepare it for sale. That's a good thing!			

07/17/2018	Boch Toyota South North Attleboro, MA 508-699-7551 bochtoyotasouth.com	Vehicle sold
★ 4.6 / 5.0 593 Verified Reviews ❤️ 29 Customer Favorites		

07/18/2018 37,927	Boch Toyota South North Attleboro, MA 508-699-7551 bochtoyotasouth.com		Vehicle serviced
★ 4.6 / 5.0 593 Verified Reviews ❤️ 29 Customer Favorites			

 Owner 2 Purchased: 2018	Personal Vehicle 10,381 mi/yr
---	----------------------------------

Date	Mileage	Source	Comments
07/30/2018		Rhode Island Motor Vehicle Dept. Warwick, RI Title #20207931	Title issued or updated - Registration issued or renewed - New owner reported - Loan or lien reported - Vehicle color noted as White
08/28/2018	40,000	L&S Automotive Center East Greenwich, RI 401-398-8222 lsautorepair.com/	 Vehicle serviced - Emissions or safety inspection performed
★ 5.0 / 5.0 31 Verified Reviews ❤️ 18 Customer Favorites			

08/29/2018	40,478	Boch Toyota South North Attleboro, MA 508-699-7551 bochtoyotasouth.com ★ 4.6 / 5.0 593 Verified Reviews ❤️ 29 Customer Favorites		Vehicle serviced - Maintenance inspection completed - Drivability/performance checked - Rack and pinion replaced
11/02/2018	43,339	Rhode Island Motor Vehicle Dept. Warwick, RI Title #20264558		Title issued or updated - Loan or lien reported
02/11/2019		Rhode Island Motor Vehicle Dept. Warwick, RI		Registration issued or renewed - Vehicle color noted as White
07/03/2019		Rhode Island Motor Vehicle Dept. Warwick, RI Title #20403833		Title issued or updated - Loan or lien reported
07/29/2019	51,763	New Jersey Motor Vehicle Dept. Hoboken, NJ Title #JC20192100438		Title issued or updated - Registration issued or renewed - Loan or lien reported - Registration updated when owner moved the vehicle to a new location - Vehicle color noted as White
06/18/2020		New Jersey Motor Vehicle Dept. Hoboken, NJ		Registration issued or renewed - Vehicle color noted as White
07/01/2021		New Jersey Motor Vehicle Dept. Hoboken, NJ		Registration issued or renewed - Registration updated when owner moved the vehicle to a new location - Vehicle color noted as White
08/17/2021		New Jersey Motor Vehicle Dept. Hoboken, NJ		Registration issued or renewed - Vehicle color noted as White
03/23/2022	78,303	Stateline Nissan East Providence, RI 401-432-2000 statelinenissanauto.com/ ★ 4.4 / 5.0 368 Verified Reviews ❤️ 1,047 Customer Favorites		Vehicle serviced - Maintenance inspection completed - Air filter replaced - Engine/powertrain computer/module checked - Fuel system cleaned/serviced - Induction system serviced - Mass air flow sensor replaced - Throttle body cleaned/serviced
03/31/2022	78,514	Hudson Nissan Jersey City, NJ		Vehicle serviced - Maintenance inspection completed

201-435-2003
hudsonnissan.com

★ 4.5 / 5.0

808 Verified Reviews

♥ 7,811 Customer Favorites

- Brake fluid flushed/changed
- Drivability/performance checked

04/21/2022 78,515

Hudson Nissan
Jersey City, NJ
201-435-2003
hudsonnissan.com

★ 4.5 / 5.0

808 Verified Reviews

♥ 7,811 Customer Favorites



Vehicle serviced

- Maintenance inspection completed
- Brake fluid flushed/changed
- Drivability/performance checked
- Seatbelts checked

05/17/2022

New Jersey
Motor Vehicle Dept.
Hoboken, NJ

Registration issued or renewed

- Vehicle color noted as White

09/29/2022

Damage Report



Accident reported

- Damage to rear
- Vehicle was not damaged

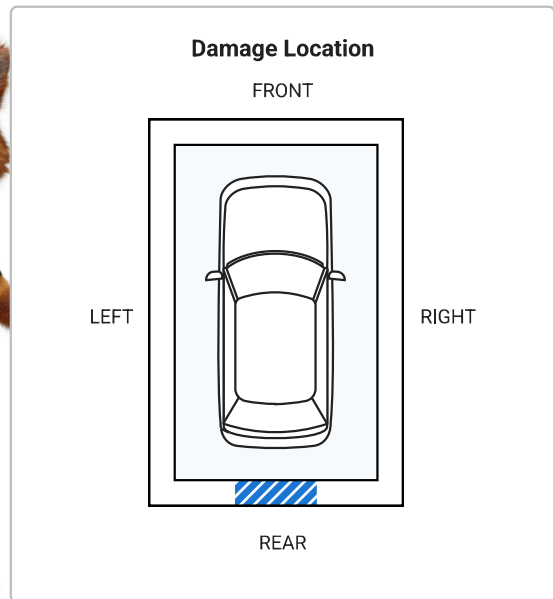

CARFAX HAS THE MOST ACCIDENT & DAMAGE INFORMATION

09/30/2022 82,493

New Jersey
Inspection Station

Passed emissions inspection

03/23/2023

Nissan North America
Inc.

Manufacturer Safety recall issued

- NHTSA #23V-093
- Recall #R22C9 ROGUE MCH KEY SPCR NTB23-068

-Status: Remedy Available

Locate an authorized Nissan dealer near you to obtain more information about this recall

+ Learn more about this recall

05/17/2023	New Jersey Motor Vehicle Dept. Hoboken, NJ	Registration issued or renewed -Vehicle color noted as White
10/13/2023	Rhode Island Motor Vehicle Dept. East Greenwich, RI	Registration issued or renewed -Vehicle color noted as White

 **Owner 3** Personal Vehicle
Purchased: 2023

Date	Mileage	Source	Comments
10/13/2023	96,252	Rhode Island Motor Vehicle Dept. East Greenwich, RI Title #21241101	Title issued or updated -New owner reported
10/16/2025		Rhode Island Motor Vehicle Dept. East Greenwich, RI	Registration issued or renewed -Vehicle color noted as White

 **Owner 4** Personal Vehicle
Purchased: 2025

Date	Mileage	Source	Comments
10/16/2025	114,837	Rhode Island Motor Vehicle Dept. East Greenwich, RI Title #21664959	Title issued or updated -New owner reported



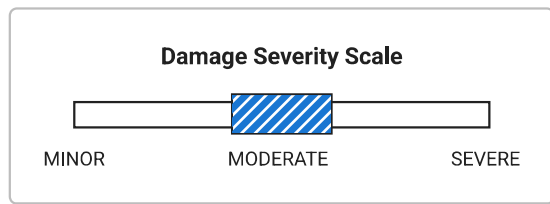

11/19/2025	Damage Report	 Damage reported: moderate damage -Damage to front -Damage to left side -Damage to left front -Damage to right front
------------	---------------	--

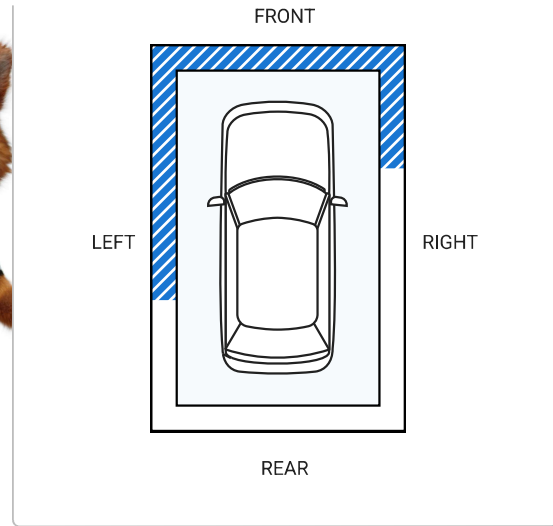

Damage Location



CARFAX HAS THE MOST ACCIDENT & DAMAGE INFORMATION

12/30/2025	Damage Report	 TOTAL LOSS VEHICLE
		<div style="border: 1px solid blue; padding: 5px;"> <p>There are many reasons an insurance company will declare a vehicle a total loss. Have this vehicle inspected by a qualified technician before you buy. Learn More</p> </div>
12/30/2025	Rhode Island Motor Vehicle Dept.	Title or registration issued to insurance company
12/30/2025	115,667 Rhode Island Motor Vehicle Dept. Exeter, RI Title #S1091844	 SALVAGE TITLE/CERTIFICATE ISSUED
01/03/2026	Auto Auction	Vehicle sold
01/03/2026	Damage Report	 SALVAGE TITLE/CERTIFICATE ISSUED

Have Questions? Consumers, please visit our Help Center at www.carfax.com. Dealers or Subscribers, please visit our Help Center at www.carfaxonline.com.



Glossary

Accident Indicator

CARFAX receives information about accidents in all 50 states, the District of Columbia and Canada.

Not every accident is reported to CARFAX. As details about the accident become available, those additional details

are added to the CARFAX Vehicle History Report. CARFAX recommends that you have this vehicle inspected by a qualified mechanic.

- According to the National Safety Council, Injury Facts, 2021 edition, 5% of the 276 million registered vehicles in the U.S. were involved in an accident in 2019. Over 77% of these were considered minor or moderate.
- This CARFAX Vehicle History Report is based only on information supplied to CARFAX and available as of 1/24/26 at 2:51:04 AM (CST). Other information about this vehicle, including problems, may not have been reported to CARFAX. Use this report as one important tool, along with a vehicle inspection and test drive, to make a better decision about your next used car.

Damage Indicator

Damage can be a result of many different types of events. Examples include contact with objects (other cars, trees, traffic signs, road debris, etc), vandalism, or weather-related events. Not every damage event is reported to CARFAX. As details about the damage event become available, those additional details are added to the CARFAX Vehicle History Report. CARFAX recommends that you have this vehicle inspected by a qualified mechanic.

- This CARFAX Vehicle History Report is based only on information supplied to CARFAX and available as of 1/24/26 at 2:51:04 AM (CST). Other information about this vehicle, including problems, may not have been reported to CARFAX. Use this report as one important tool, along with a vehicle inspection and test drive, to make a better decision about your next used car.

Damage Severity

Damage events result in one of the following severity levels:

- Minor: Generally, minor damage is cosmetic (including dents or scratches), may only require reconditioning, and typically does not compromise a vehicle's operation and/or safety.
- Moderate: Moderate damage may affect multiple components of the vehicle and may impair the vehicle's operation and/or safety.
- Severe: Severe damage usually affects multiple components of the vehicle and is likely to compromise the vehicle's operation and/or safety.

CARFAX recommends getting a pre-purchase inspection at a certified collision repair facility.

First Owner

When the first owner(s) obtains a title from a Department of Motor Vehicles as proof of ownership.

Manufacturer Recall

Automobile manufacturers issue recall notices to inform vehicle owners of a safety defect or failure to meet minimum federal safety or emissions standards. Manufacturer recalls are repaired at no cost to the customer.

New Owner Reported

When a vehicle is sold to a new owner, the Title must be transferred to the new owner(s) at a Department of Motor Vehicles.

Ownership History

CARFAX defines an owner as an individual or business that possesses and uses a vehicle. Not all title transactions represent changes in ownership. To provide estimated number of owners, CARFAX proprietary technology analyzes all the events in a vehicle history. Estimated ownership is available for vehicles manufactured after 1991 and titled solely in the US including Puerto Rico. Dealers sometimes opt to take ownership of a vehicle and are required to in the following states: Maine, Massachusetts, New Jersey, Ohio, Oklahoma, Pennsylvania and South Dakota. Please consider this as you review a vehicle's estimated ownership history.

Rental

Vehicle was registered by a rental agency.

Salvage Title



A Salvage Title is issued on a vehicle damaged to the extent that the cost of repairing the vehicle exceeds approximately 75% of its pre-damage value. This damage threshold may vary by state. Some states treat Junk titles the same as Salvage but the majority use this title to indicate that a vehicle is not road worthy and cannot be titled again in that state. The following eleven states also use Salvage titles to identify stolen vehicles - AZ, FL, GA, IL, MD, MN, NJ, NM, NY, OK and OR.

Title Issued

A state issues a title to provide a vehicle owner with proof of ownership. Each title has a unique number. Each title or registration record on a CARFAX report does not necessarily indicate a change in ownership. In Canada, a registration and bill of sale are used as proof of ownership.

Total Loss Vehicle

An insurance or fleet company declares a vehicle a total loss when a claim exceeds approximately 75% of its pre-damage value or if the vehicle is stolen and not recovered. This damage threshold varies by company. These companies typically take possession and obtain the title. Not all total loss vehicles result in a DMV-reported branded title. This may occur when an insurance company's definition of a total loss is different than the state DMV's definition for a branded title or when the owner of the vehicle is a self-insured company, like a fleet or rental company.

Follow Us:  facebook.com/CARFAX  [@CARFAXinc](https://twitter.com/CARFAXinc)  **About CARFAX**

CARFAX DEPENDS ON ITS SOURCES FOR THE ACCURACY AND RELIABILITY OF ITS INFORMATION. THEREFORE, NO RESPONSIBILITY IS ASSUMED BY CARFAX OR ITS AGENTS FOR ERRORS OR OMISSIONS IN THIS REPORT. CARFAX FURTHER EXPRESSLY DISCLAIMS ALL WARRANTIES, EXPRESS OR IMPLIED, INCLUDING ANY IMPLIED WARRANTIES OF MERCHANTABILITY OR FITNESS FOR A PARTICULAR PURPOSE.

© 2026 CARFAX, Inc., part of S&P Global. All rights reserved.
1/24/26 2:51:04 AM (CST)

I have reviewed and received a copy of the CARFAX Vehicle History Report for this 2017 NISSAN ROGUE vehicle (VIN: KNMAT2MT3HP564286), which is based on information supplied to CARFAX and available as of 1/24/26 at 3:51 AM (EST).

Customer Signature

Date

Dealer Signature

Date